

# AXIOM

## Esploso componenti Exploded view Liste des composants

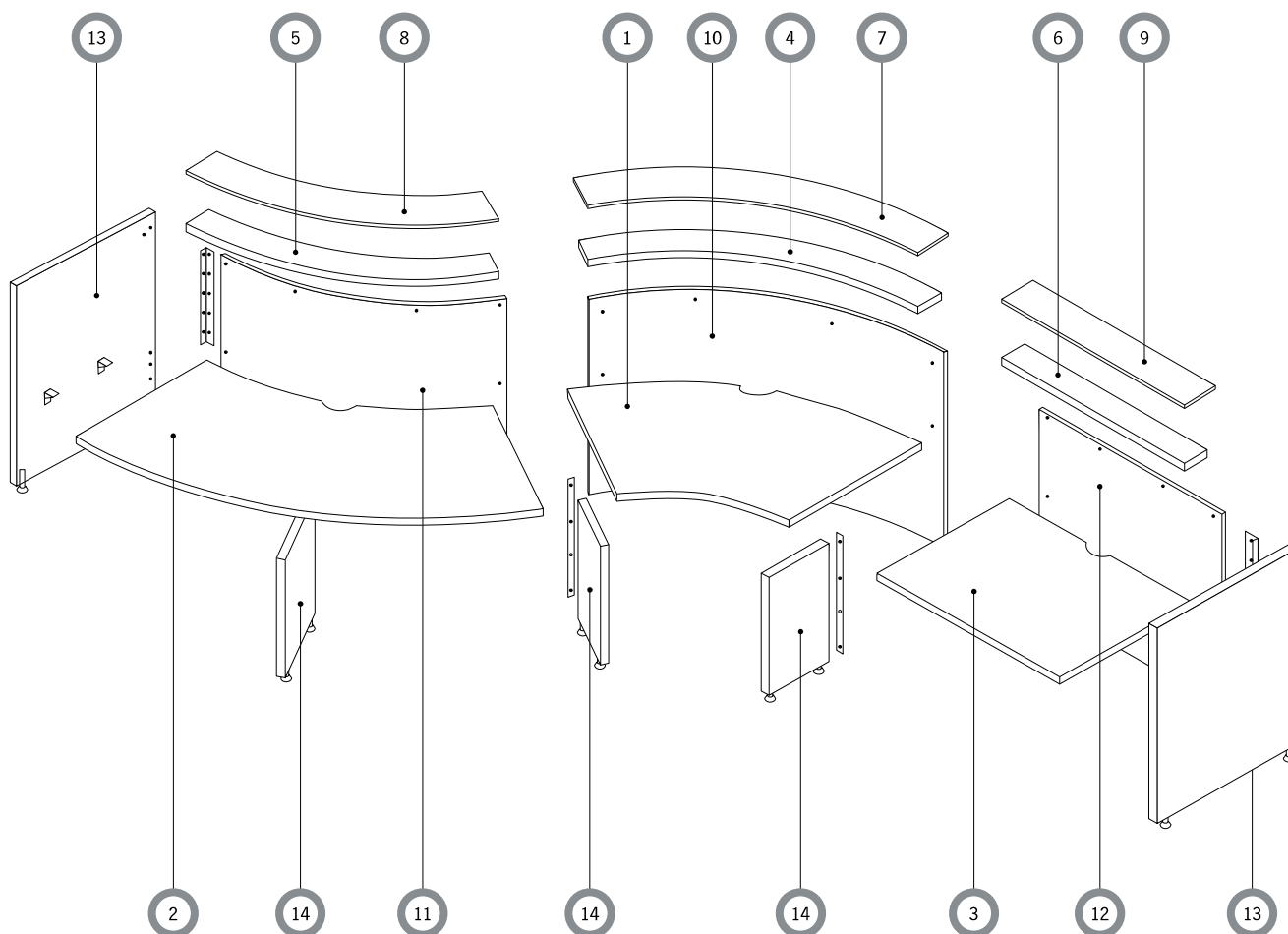

- |    |   |     |   |
|----|---|-----|---|
| 1: | <b>Piano di lavoro curvo interno</b><br>Inner curved work top<br>Plan de travail courbe interne                   | 8:  | <b>Piano cristallo curvo esterno</b><br>Outer curved glass top<br>Plan de travail courbe externe en verre |
| 2: | <b>Piano di lavoro curvo esterno</b><br>Outer curved work top<br>Plan de travail courbe externe                   | 9:  | <b>Piano cristallo dritto</b><br>Straight glass top<br>Plan de travail droit en verre                     |
| 3: | <b>Piano di lavoro dritto</b><br>Straight work top<br>Plan de travail droit                                       | 10: | <b>Schienale curvo interno</b><br>Inner curved front panel<br>Voile de fond courbe interne                |
| 4: | <b>Pianetto superiore curvo interno</b><br>Inner curved upper small top<br>Petit plateau supérieur courbe interne | 11: | <b>Schienale curvo esterno</b><br>Outer curved front panel<br>Voile de fond courbe externe                |
| 5: | <b>Pianetto superiore curvo esterno</b><br>Outer curved upper small top<br>Petit plateau supérieur courbe externe | 12: | <b>Schienale dritto</b><br>Straight front panel<br>Voile de fond droite                                   |
| 6: | <b>Pianetto superiore dritto</b><br>Straight upper small top<br>Petit plateau supérieur droit                     | 13: | <b>Fianchi terminali</b><br>Ending sides<br>Panneaux finals   |
| 7: | <b>Piano cristallo curvo interno</b><br>Inner curved glass top<br>Plan de travail courbe interne en verre         | 14: | <b>Fianchetti intermedi</b><br>Intermediate small sides<br>Petits panneaux mitoyens                       |

**Sezione bancone Axiom**  
**Axiom reception section**  
**Séction du comptoir Axiom**

---

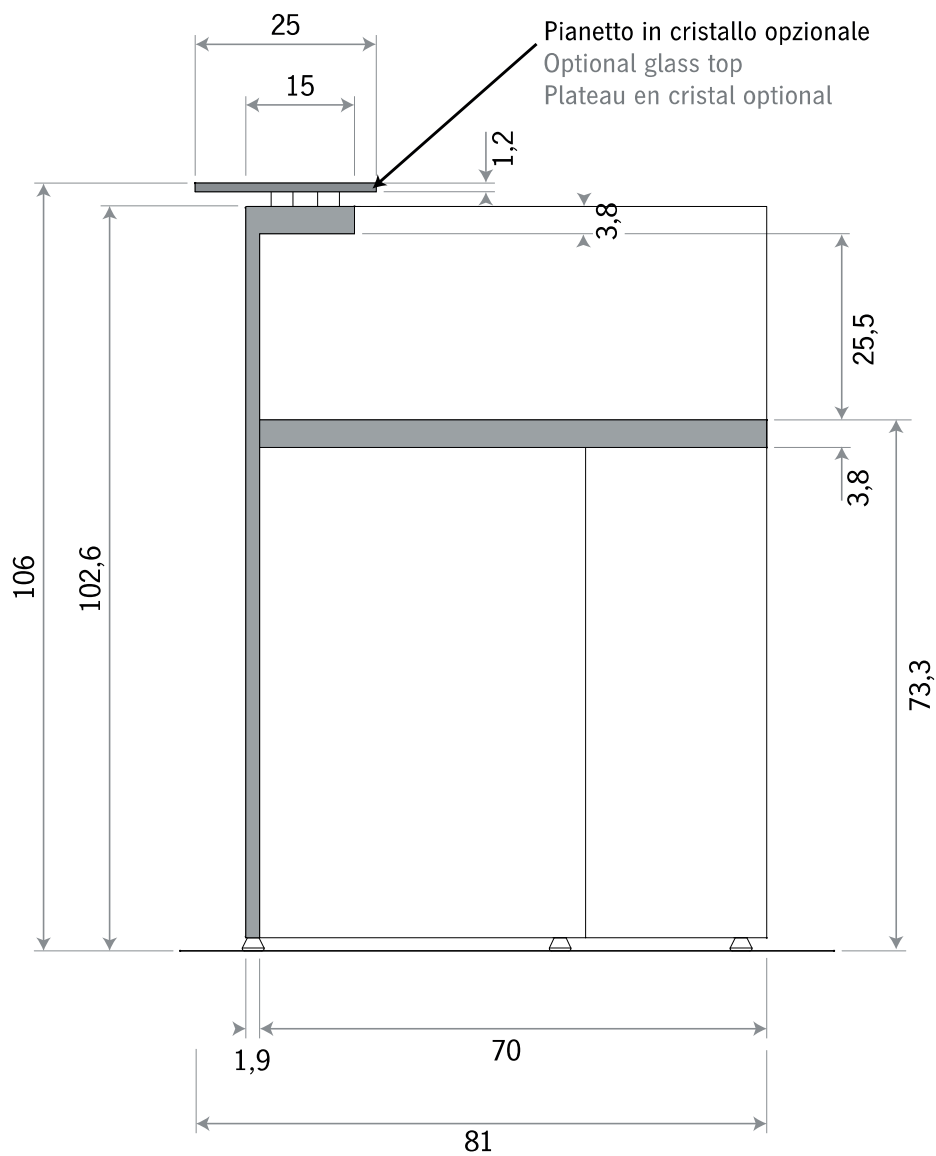

# Dimensioni d'ingombro

## Dimensions

## Encombrement

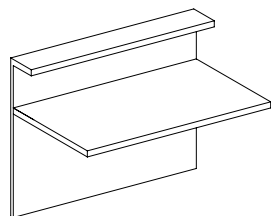

**ART. BDA 120**

Con top in cristallo  
With glass top  
Avec plateau en cristal

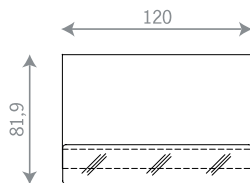

Senza top in cristallo  
Without glass top  
Sans plateau en cristal

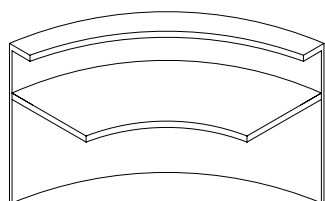
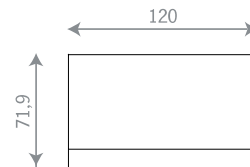

**ART. BMA 155**

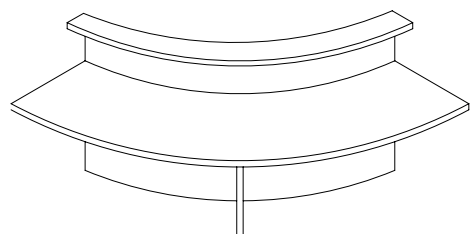
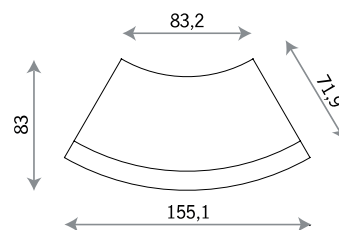
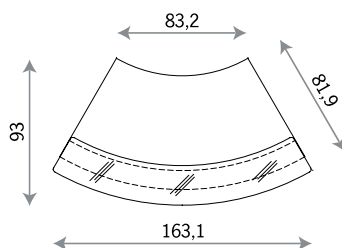

**ART. BMA 225**

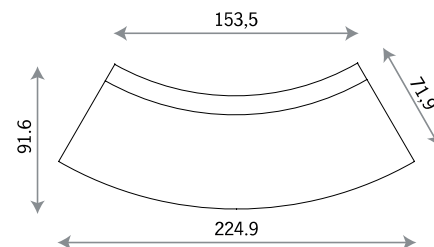
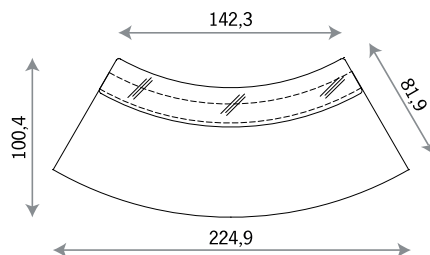

# Dimensioni d'ingombro

## Dimensions

## Encombrement

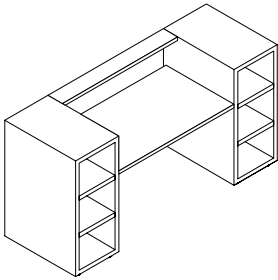

**ART. BDA 120  
+ CCA 045**

Con top in cristallo  
With glass top  
Avec plateau en cristal

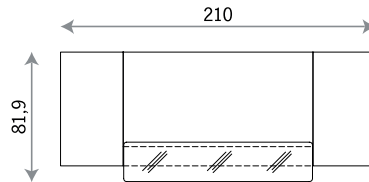

Senza top in cristallo  
Without glass top  
Sans plateau en cristal

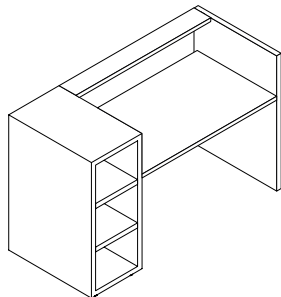
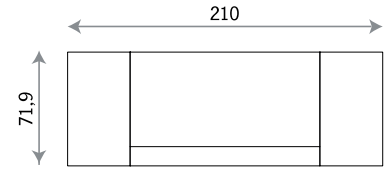

**ART. BDA 120  
+ CLA 045 SX**

Con top in cristallo  
With glass top  
Avec plateau en cristal

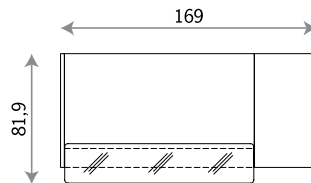

Senza top in cristallo  
Without glass top  
Sans plateau en cristal

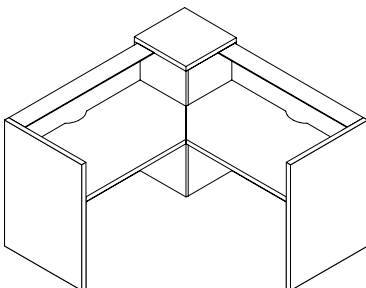
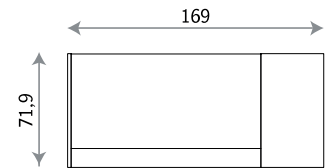

**ART. ABA 165  
+ FBA 105**

Con top in cristallo  
With glass top  
Avec plateau en cristal

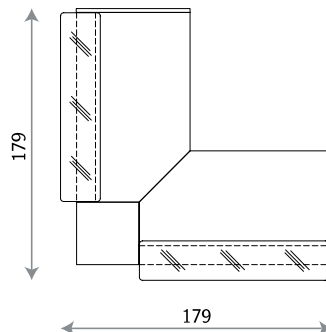

Senza top in cristallo  
Without glass top  
Sans plateau en cristal

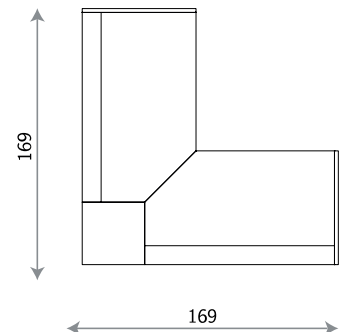

# Axiom colour chart

## FINISHING\_FINISHURE

### TOPS, SIDES, LATERAL UNITS AND CORNER MODULES PIANI, FIANCHI, CONTENITORI LATERALI E RACCORDI AD ANGOLO



### STRAIGHT FRONTAL PANELS\_PANNELLI FRONTALI DRITTI



### METAL CURVED FRONTAL PANELS\_PANNELLI FRONTALI CURVI IN METALLO



### GLASS TOP\_PIANETTI IN VETRO



### ACCEPTANCE TOP WITH LED\_PIANO ACCOGLIENZA CON LED

